

FERRO PROFILATO A FREDDO

- **“ELLE”**
- **ANGOLARE**
- **“U”**
- **FERMAVETRO /
VITI**
- **OMEGA**
- **ARCARECCIO**
- **“C”**
- **MONOROTAIA /
CARRELLI**
- **BINARIO / RUOTE /
OLIVE**

“ELLE”

UNI 7070-82 Fe 360 B

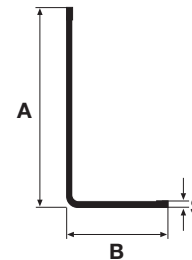

**FERRO
PROFILATO
A FREDDO**

Dimensioni A x B mm.	SPESSORE									
	0,8	1	1,2	1,5	2	2,5	3	4	5	6
15 x 10		0,19	0,22	0,27						
20 x 10		0,23	0,27	0,33						
25 x 10		0,27	0,32	0,39						
30 x 10		0,30	0,36	0,45						
20 x 15		0,27	0,32	0,39	0,50					
25 x 15		0,30	0,36	0,45	0,58					
30 x 15		0,35	0,40	0,50	0,66	0,83	0,99			
35 x 15			0,46	0,57	0,74	0,90	1,05			
40 x 15				0,63	0,83	1,03	1,22			
30 x 20				0,56	0,75	0,93	1,10			
35 x 20				0,63	0,83	1,03	1,22			
40 x 20				0,68	0,94	1,14	1,34			
50 x 20					1,06	1,32	1,56			
60 x 20					1,22	1,52	1,81			
30 x 25				0,63	0,83	1,03	1,22			
50 x 25					1,14	1,42	1,70			
35 x 30				0,74	0,97	1,20	1,41			
40 x 30				0,80	1,06	1,32	1,56			
50 x 30					1,22	1,52	1,81			

“ELLE”

UNI 7070-82 Fe 360 B

**FERRO
PROFILATO
A FREDDO**

Dimensioni A x B mm.	SPESSORE										
	0,8	1	1,2	1,5	2	2,5	3	4	5	6	
60 x 30					1,46	1,72	2,04				
70 x 30						1,90	2,25				
40 x 35				0,86	1,13	1,40	1,65				
50 x 35					1,29	1,60	1,89				
60 x 35					1,45	1,80	2,13				
50 x 40					1,37	1,70	2,01	2,62	3,27		
60 x 40					1,53	1,90	2,25	2,94	3,67		
70 x 40						2,10	2,49	3,26	4,07		
80 x 40						2,30	2,73	3,58	4,47	5,37	
100 x 40							3,21	4,22	5,27	6,33	
100 x 45							3,33	4,38	5,47	6,57	
60 x 50						2,10	2,49	3,26	4,07	4,88	
100 x 50							3,45	4,54	5,60	6,72	
100 x 60							3,69	4,86	6,00	7,20	
100 x 70							3,93	5,18	6,40	7,68	
100 x 80							4,17	5,50	6,80	8,16	

ANGOLARE

UNI 7070-82 Fe 360B

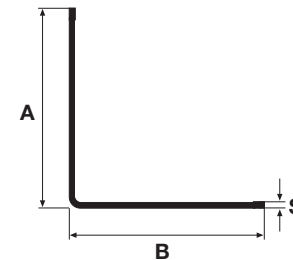

**FERRO
PROFILATO
A FREDDO**

Dimensioni A x B mm.	SPESSORE										
	0,6	0,8	1	2	1,5	2	2,5	3	4	5	6
10 x 10	0,09	0,12	0,15	0,17	0,20						
15 x 15		0,19	0,23	0,26	0,31	0,41					
20 x 20		0,25	0,31	0,36	0,43	0,56	0,72	0,84			
25 x 25			0,39	0,45	0,55	0,72	0,90	1,06			
30 x 30			0,46	0,54	0,67	0,88	1,10	1,25			
35 x 35				0,65	0,82	1,03	1,30	1,53			
40 x 40					0,94	1,20	1,45	1,75	2,30		
45 x 45						1,35	1,69	2,00	2,63		
50 x 50						1,51	1,87	2,20	2,95	3,65	4,38
60 x 60						1,75	2,27	2,70	3,50	4,40	5,28
80 x 80								3,65	4,76	6,75	8,01
100 x 100									6,00	7,45	8,94

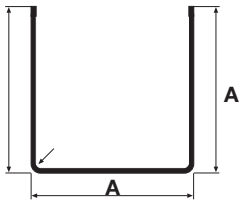

“U”

UNI 7070-82 Fe 360 B

**FERRO
PROFILATO
A FREDDO**

Dimensioni A x A x A mm.	SPESSORE											
	0,7	0,8	1	1,2	1,5	2	2,5	3	4	5	6	
8x 8x 8	0,12	0,14	0,16	0,19	0,21							
10x 10x 10	0,15	0,17	0,21	0,24,	0,29							
12x 12x 12	0,19	0,21	0,26	0,30	0,36							
14x 14x 14	0,22	0,25	0,31	0,36	0,43							
15x 15x 15	0,24	0,27	0,33	0,39	0,47	0,59						
20x 20x 20	0,32	0,37	0,45	0,53	0,65	0,83						
22x 22x 22	0,36	0,40	0,50	0,59	0,72	0,93						
25x 25x 25			0,57	0,68	0,83	1,07	1,30	1,49				
26x 26x 26			0,60	0,71	0,87	1,12	1,36	1,59				
28x 28x 28				0,76	0,94	1,22	1,48	1,73				
30x 30x 30				0,82	1,00	1,31	1,60	1,87				
35x 35x 35					1,19	1,55	1,90	2,23				
40x 40x 40					1,37	1,79	2,20	2,59	3,33			
45x 45x 45						2,07	2,50	2,95	3,81			
50x 50x 50							2,28	2,80	3,31	4,29	5,40	
60x 60x 60							2,76	3,40	4,04	5,25	6,56	
70x 70x 70								4,00	4,76	6,21	7,76	
80x 80x 80									5,48	7,11	8,89	
90x 90x 90									6,20	8,13	10,16	
100x100x100									6,92	9,01	11,26	13,30
120x120x120									8,35	11,00	13,60	16,12

“U” ZINCATO: 30x30x2; 35x35x2; 40x40x2; 45x45x2; 50x50x3

“U”

UNI 7070-82 Fe 360 B



**FERRO
PROFILATO
A FREDDO**

Dimensioni A x B x A mm.	SPESSORE									
	0,8	1	1,2	1,5	2	2,5	3	4	5	6
35x 20x 35		0,688	0,817	1,000	1,310	1,60	1,87			
40x 20x 40			0,913	1,130	1,470	1,80	2,11			
30x 25x 30	0,530	0,648	0,769	0,948	1,230	1,50	1,75			
35x 25x 35	0,587	0,728	0,865	1,070	1,390	1,70	1,99			
40x 25x 40		0,808	0,961	1,180	1,550	1,90	2,23			
10x 30x 10		0,368	0,433	0,528	0,672					
15x 30x 15		0,448	0,529	0,648	0,832	1,00	1,15			
20x 30x 20		0,528	0,625	0,768	0,992	1,20	1,39			
25x 20x 25		0,608	0,721	0,888	1,150	1,40	1,63			
40x 30x 40			1,000	1,240	1,630	2,00	2,35			
50x 30x 50				1,490	1,950	2,40	2,83			
20x 35x 20			0,673	0,828	1,070	1,30	1,51			
25x 35x 25			0,769	0,948	1,230	1,50	1,75			
30x 35x 30			0,865	1,060	1,390	1,70	1,99			
50x 35x 50			1,250	1,550	2,030	2,50	2,95			
20x 40x 20				0,888	1,150	1,40	1,63			
30x 40x 30				1,130	1,470	1,80	2,11	2,69	3,20	
35x 40x 35				1,250	1,630	2,00	2,35	3,00	3,60	
40x 45x 40				1,430	1,870	2,30	2,71	3,49	4,20	
20x 50x 20				1,010	1,310	1,60	1,87	12,37	2,80	
25x 50x 25				1,120	1,470	1,80	2,11	2,69	3,20	

“U”

UNI 7070-82 Fe 360 B

**FERRO
PROFILATO
A FREDDO**

Dimensioni A x B x A mm.	SPESSORE										
	0,8	1	1,2	1,5	2	2,5	3	4	5	6	
30x 50x 30				1,250	1,630	2,00	2,35	3,00	3,60		
40x 50x 40				1,490	1,950	2,40	2,83	3,65	4,40		
20x 60x 20				1,130	1,470	1,80	2,11	2,69			
30x 60x 30				1,370	1,790	2,20	2,59	3,33	4,00		
40x 60x 40				1,610	2,110	2,60	3,07	3,97	4,80		
35x 70x 35				1,610	2,110	2,60	3,07	3,97	4,80		
40x 80x 40				1,850	2,430	3,00	3,55	4,60	5,60		
50x 80x 50				2,090	2,750	3,40	4,03	5,25	6,40		
45x 90x 45				2,090	2,750	3,40	4,03	5,25	6,40		
50x 100x 50				2,33	3,07	3,80	4,51	5,89	7,20		
50x 120x 50				2,57	3,39	4,20	4,99	6,52	8,00	9,41	
60x 120x 60					3,71	4,60	5,47	7,17	8,80	10,37	
60x 140x 60					8,19	5,00	5,95	7,80	9,60	11,32	
50x 150x 50				2,93	3,87	4,80	5,71	7,49	9,20	10,85	
65x 160x 65					4,35	5,40	6,43	8,45	10,40	12,29	
80x 200x 80							7,87	10,37	12,80	15,17	
100x 200x 100							9,31	12,29	15,20	18,05	
100x 220x 100							9,79	12,93	16,00	19,00	
100x 250x 100							10,51	13,89	17,20	20,45	
100x 300x 100							11,71	15,49	19,20	22,85	

FERMAVETRO VITI

FERRO
PROFILATO
A FREDDO

Fermavetro nero e zincato

Sp = 0.6 / peso Kg. ml. 0,20

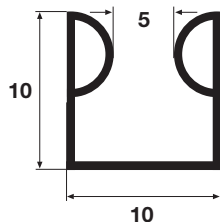

Sp = 0.6 / peso Kg. ml. 0,23

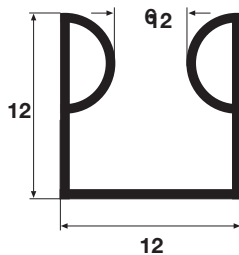

Viti

zincate



nylon



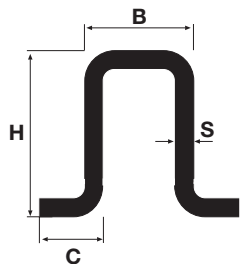

OMEGA

UNI 7070-82 Fe 360B

**FERRO
PROFILATO
A FREDDO**

Dimensioni H x B x C mm.	SPESSORE					
	1,5	2	2,5	3	3,5	4
25x 30x 15	1,22	1,60				
45x 30x 15	1,70	2,23				
50x 30x 20	1,93	2,54	3,14			
60x 40x 25		3,17	3,92	4,66		
80x 40x 25		3,80	4,71	5,60		
100x 50x 30		4,74	5,88	7,01		
100x 60x 30			6,08	7,25		
100x 60x 42			6,55	7,82		
120x 50x 40			7,06	8,43		
120x 60x 30			6,86	8,20		
120x 80x 40			7,65	9,14		

OMEGA ZINCATO: 20x50x30x2; 25x60x40x2; 25x80x40x3; 30x100x50x3; 30x120x60x3

“C”

UNI 7070-82 Fe 360B

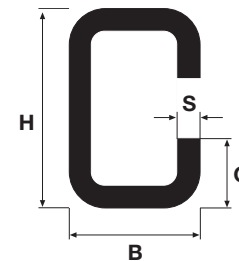

**FERRO
PROFILATO
A FREDDO**

Dimensioni H x B x C mm.	SPESSORE						
	1	1,2	1,5	2	2,5	3	3,5
30x 30x 10			1,22	1,60	1,96	2,38	
40x 20x 10		0,90	1,11	1,33			
40x 40x 10			1,58	2,07			
40x 40x 15				2,23	2,75	3,25	
50x 30x 15			1,58	2,07			
50x 30x 20					2,75	3,25	
50x 40x 15			1,81	2,39			
50x 40x 20					3,14	3,72	
60x 40x 20				2,70	3,33	3,96	
60x 50x 15				2,86	3,53		
60x 50x 20				3,01	3,73	4,43	
80x 40x 15				2,86	3,53	4,19	
80x 40x 20				3,01	3,73	4,43	
100x 50x 25				3,80	4,71	5,60	

ARCARECCIO TIPO FIAT

UNI 7070-82 Fe 360B

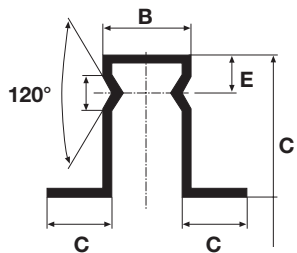

**FERRO
PROFILATO
A FREDDO**

Tipo GB	Dimensioni					SPESSORE			
	H	B	C	E	D	2	2,5	3	3,5
10	50	35	28	22	24	3,02	3,75		
11	60	35	30	19,5	17	3,30	4,11		
12	75	35	30	19,5	17	3,76	4,70		
13	100	40	26,5	35	34		5,12	6,70	
14	100	60	30	35	34		6,13	7,33	
15	100	60	42	35	34		6,60	7,89	
16	105	60	42	35	34		6,80	8,12	
17	120	50	40	35	34		7,10	8,50	
18	120	60	30	35	34		6,91	8,27	
19	120	80	40	35	34		7,69	9,21	
20	150	80	43,5	47	40		9,03	10,78	12,51
21	150	82	42,5	47	40		9,03	10,78	12,51

MONOROTAIA CARRELLI

**FERRO
PROFILATO
A FREDDO**

Monorotaia

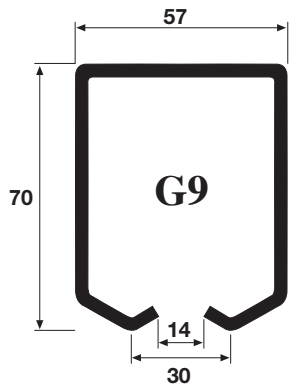

30/10 = Kg./ml.5,25

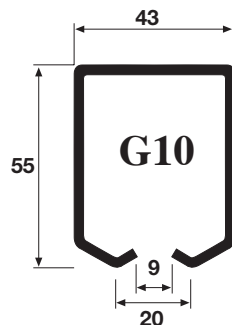

25/10 = Kg./ml.3,34

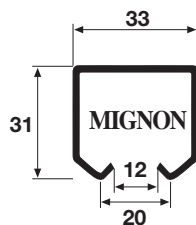

18/10 = Kg./ml.1,22

Carrelli

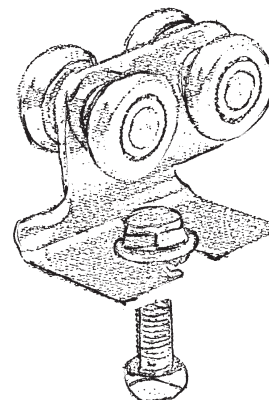

MIGNON

semplici
(2 ruote)

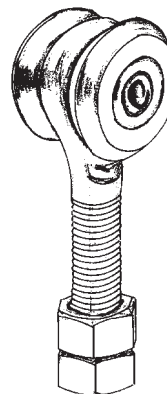

G9 - G10

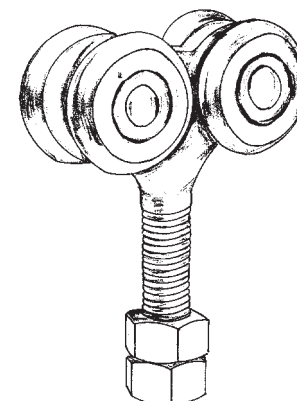

doppi
(4 ruote)
G9 - G10

BINARIO RUOTE OLIVE

FERRO
PROFILATO
A FREDDO

Binario

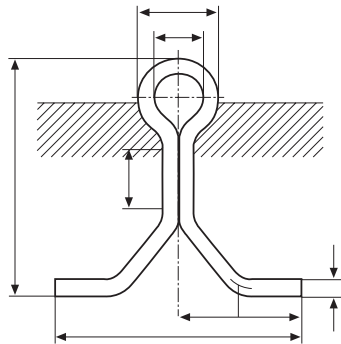

omega zincato mt. 6

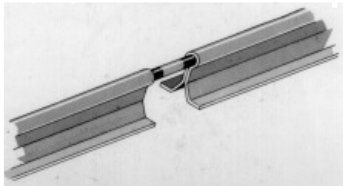

spinotto da giunzione

Ruote

gola tonda e gola V

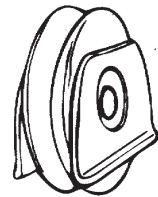
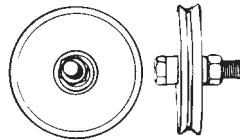

CSE

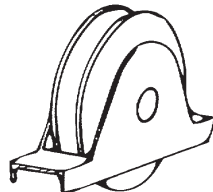

CSS

Olive

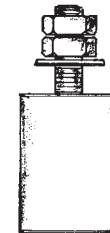

in nylon
Ø 30 e Ø 40